



AL15/AL10 ALUMINUM RAILING SYSTEM



STYLISH VERSATILITY. TRUSTWORTHY CRAFTSMANSHIP.

Long-lasting, rust-resistant aluminum railing that seamlessly combines functionality with modern design.

RailMaster AL15/AL10 Aluminum Railing expertly blends superior craftsmanship and modern design, creating a visually striking and dependable railing solution that can elevate any outdoor living space. Its sleek, high-quality design not only enhances the aesthetic appeal of the space but also reflects your unwavering commitment to delivering excellence in every detail.

Designed for professional contractors, RailMaster features pre-assembled level rail panels and plated posts with pre-mounted brackets for quick installation. We also offer easy-to-assemble knock-down kits for added flexibility without compromising on quality.

Elevate your next railing project with RailMaster - built to endure the elements!

- AAMA 2605 Grade Textured Black Powder Coating Finish for Durability
- 20-year Limited Warranty for Residential Applications
- 10-year Limited Warranty for Commercial Applications

AL15/AL10 LEVEL RAIL PANEL

- Factory Assembled Level Rail Section for Ease of Installation
- Panels Available in 6' and 8' Lengths; 36" and 42" Heights
- Square Balusters: 3/4" and 5/8" Options
- Top & Bottom Rails: 1-1/2"W x 1-1/4"H
- Top Rail Armor Encapsulates Top Rail for Strength: 1.85"W x 1.32"H
- 8' Level Rail Panels Include a Fixed Foot Block for Added Support

AL15 LEVEL RAIL PANEL - 3/4"		
N25010	6'x36"	3/4" Baluster (15 ct)
N25016	6'x42"	3/4" Baluster (15 ct)
N25011	8'x36"	3/4" Baluster (20 ct)
N25017	8'x42"	3/4" Baluster (20 ct)

AL10 LEVEL RAIL PANEL - 5/8"		
N23655	6'x36"	5/8" Baluster (15 ct)
N23657	6'x42"	5/8" Baluster (15 ct)
N23659	8'x36"	5/8" Baluster (20 ct)
N23661	8'x42"	5/8" Baluster (20 ct)

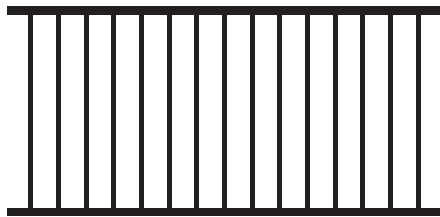

6' Wide Level Rail Panel

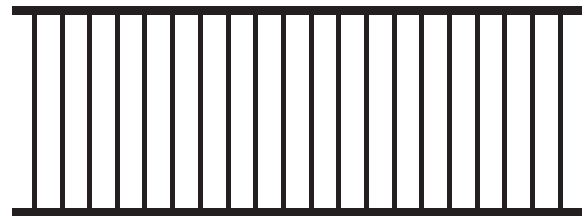

8' Wide Level Rail Panel

AL15/AL10 LEVEL & STAIR RAIL KITS

- Knock-Down Kits are Available for Ease of Transport
- Rail Kits Available in 6' and 8' Lengths; 36" and 42" Heights
- Top and Bottom Rails with Pre-routed Holes to Assist with Baluster Spacing

Rail Kits Include:

- Square Balusters: 3/4" and 5/8" Options
- Top & Bottom Rails: 1-1/2"W x 1-1/4"H
- Top Rail Armor Encapsulates Top Rail for Strength: 1.85"W x 1.32"H
- Level Rail Kit: Fixed Foot Block for 8' Rail for Added Support
- Stair Rail Kit: Adjustable Foot Block for 8' Rail for Added Support

AL15 LEVEL RAIL KITS - 3/4"		
N25012	6'x36"	3/4" Baluster (15 ct)
N25018	6'x42"	3/4" Baluster (15 ct)
N25013	8'x36"	3/4" Baluster (20 ct)
N25019	8'x42"	3/4" Baluster (20 ct)

AL15 STAIR RAIL KITS - 3/4"		
N25014	6'x36"	3/4" Baluster (15 ct)
N25020	6'x42"	3/4" Baluster (15 ct)
N25015	8'x36"	3/4" Baluster (20 ct)
N25021	8'x42"	3/4" Baluster (20 ct)

AL10 LEVEL RAIL KITS - 5/8"		
N23666	6'x36"	5/8" Baluster (15 ct)
N23668	6'x42"	5/8" Baluster (15 ct)
N23670	8'x36"	5/8" Baluster (20 ct)
N23672	8'x42"	5/8" Baluster (20 ct)

AL10 STAIR RAIL KITS - 5/8"		
N23663	6'x36"	5/8" Baluster (15 ct)
N23665	6'x42"	5/8" Baluster (15 ct)
N23667	8'x36"	5/8" Baluster (20 ct)
N23669	8'x42"	5/8" Baluster (20 ct)

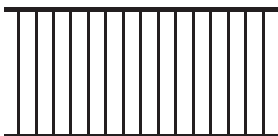

6' Wide Level Rail Panel Kit

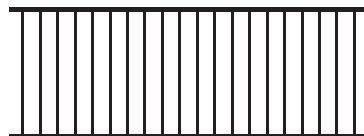

8' Wide Level Rail Panel Kit



6' Wide Stair Rail Panel Kit

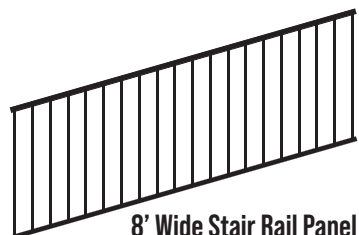

8' Wide Stair Rail Panel Kit

AL15/AL10 POST KITS

- Plated Line, Blank, and Stair Posts with Pre-drilled Anchor Holes for Faster Installation
- Posts Available in 2.5" x 2.5" [4.5" sq base plate] and 3" x 3" [5" sq base plate]
- Line Posts have Pre-mounted Brackets for Faster Installation
- Multi-use Blank Post for Corner, End, and Line Applications
- Compatible with AL15 and AL10 Aluminum Railing Systems

2.5" x 2.5"	
N23683	37" Line Post
N23679	37" Blank Post
N23685	43" Line Post
N23681	43" Blank Post
N23696	47" Stair Post
N23698	53" Stair Post

*2.5" Post for 6' Panel

3" x 3"	
N23692	37" Line Post
N23687	37" Blank Post
N23694	43" Line Post
N23690	43" Blank Post
N23700	47" Stair Post
N23701	53" Stair Post

*3" Post for 6' and 8' Panels

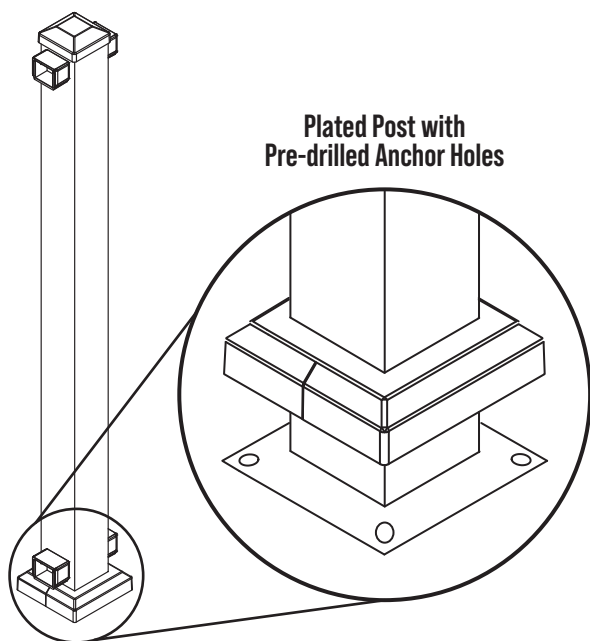

Line Post

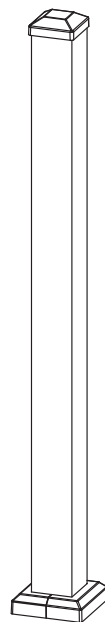

Blank Post

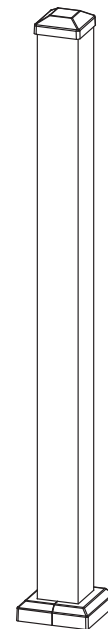

Stair Post

Line Post Kits include Plated Post with Pre-mounted Brackets, Post Cap, Post Skirt, Rail/Bracket Covers, and Screws (for securing brackets to the panel)

Blank & Stair Post Kits include Plated Post, Post Cap, and Post Skirt

- Pilot Hole Tool in Blank Post Kit to Help with Bracket Placement

*ICC ESR-5480: Tested and approved by these standards

AL15/AL10 GATES

Factory Assembled Gates with 2.5" Uprights

- Uprights: 2.5" x 2.5"
- Square Balusters: 3/4" and 5/8" Options
- Top & Bottom Rails: 1-1/2"W x 1-1/4"H
- Top Rail Armor: 1.85" x 1.32"

Gate Uprights

- 36" and 42" Height Options
- Pre-routed Hole on Top and Bottom to Slide in Panel (Sold Separately)
- Posts Sold Separately

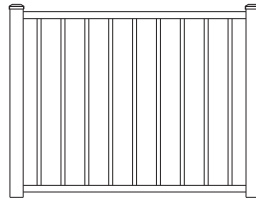

Assembled Gate

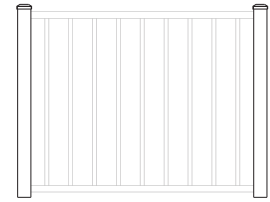

Gate Uprights

FACTORY ASSEMBLED GATES

N25307	4'x36"H Full Gate	3/4" Baluster
N25308	4'x42"H Full Gate	3/4" Baluster
N23658	4'x36"H Full Gate	5/8" Baluster
N23660	4'x42"H Full Gate	5/8" Baluster

GATE UPRIGHTS

N23662	36"H Uprights (set of 2)
N23664	42"H Uprights (set of 2)

AL15/AL10 ACCESSORIES & REPLACEMENT PARTS

Compatible with AL15 and AL10 Aluminum Railing Systems.

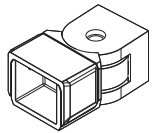

Adjustable Bracket with Screws for Level Rail

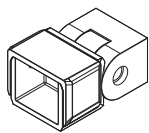

Adjustable Bracket with Screws for Stair Rail

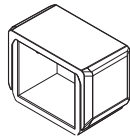

Bracket with Screws for Level Rail

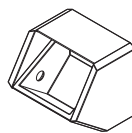

Bracket with Screws for Stair Rail

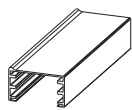

Flat Top Rail Accent with Drink Edge

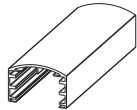

Rounded Top Rail Accent

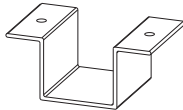

Drink Rail Bracket



Touch Up Spray



Touch Up Pen

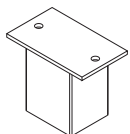

Fixed Foot Block for Level Rail

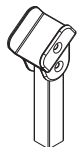

Adjustable Foot Block for Stair Rail

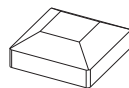

Post Cap

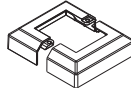

Post Trim



Torx Head Self Tapping Screw

ACCESSORIES

N23673	Adjustable Brackets for Level Rail [4 pc]*
N23743	Adjustable Brackets for Stair Rail [4 pc]*
N23671	Brackets for Level Rail [4 pc]*
N23675	Brackets for Stair Rail [4 pc]*
N23680	6' Flat Top Rail Accent with Drink Edge
N23676	6' Rounded Top Rail Accent
N23682	8' Flat Top Rail Accent with Drink Edge
N23678	8' Rounded Top Rail Accent
N23674	Drink Rail Brackets [4 pc]*
N26409	Black Touch Up Paint - Aerosol Can, 12.5 oz
N26410	Black Touch Up Paint - Pen, 3 oz

*Includes Screws

REPLACEMENT PARTS

N23677	Fixed Foot Block for Level Rail
N23744	Adjustable Foot Block for Stair Rail
N23688	2.5" Post Cap
N23684	2.5" Post Trim
N23689	3" Post Cap
N23686	3" Post Trim
N23691	#10 x 1" Torx Head Self Tapping Screw 410 SS [12 pc]



MasterHalco.com

Branch service centers are located throughout North America. RailMaster is a registered trademark of Master Halco. ©8/24

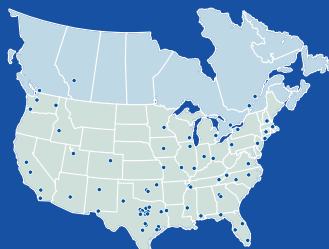

Scan me!

Find your local Master Halco branch and contact us today!